

Quick-Build™ Harness Board System

A Revolutionary Modular Solution for Harness Manufacturers

The modular, reusable solution consists of 1' X 1' (305mm x 305mm) grid tiles and specially designed, repositionable accessories that improve the productivity of wire harness assembly builds by up to 18%. The Quick-Build™ Accessories are more effective than nail, magnetic, or snap-in routing fixture methods. Accessories easily twist and lock in place until you're ready to make a change for faster routing of wires and design flexibility.

Low-Volume-High-Mix (LVHM) manufacturers achieve the greatest savings due to reduced material costs -- up to 65% of layout and board builds. By reducing the number of bulky plywood boards, the Quick-Build™ Harness Board System delivers more than 50% in storage space savings. Whether you need to build a variety of wire and cable assemblies to meet different customer specifications or for prototyping new harness designs, the more you build, the greater your profitability.

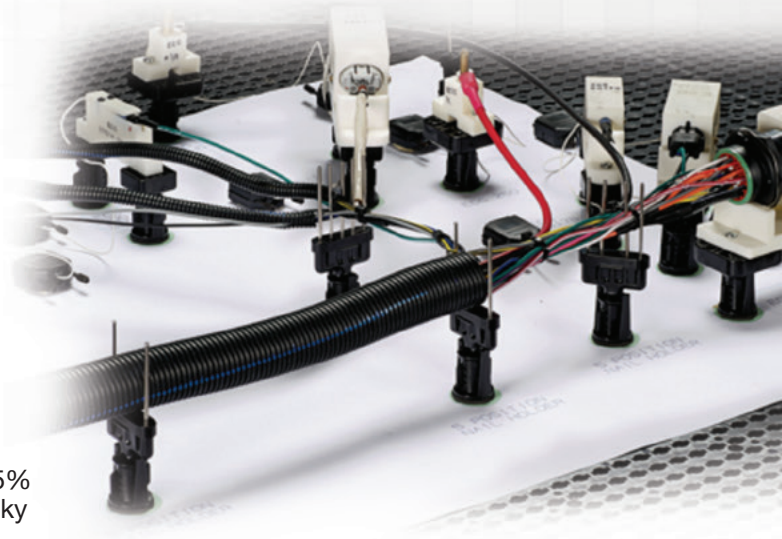

Key Features Benefits

<p>Modular Board Design 1' x 1' (305mm x 305mm) Tiles</p>	<p>Improve Productivity</p> <ul style="list-style-type: none"> • Reusable boards make it easy to move from one harness configuration to another • Scalable – Expand capacity as needed to accommodate various harness configurations <p>Improve Profitability</p> <ul style="list-style-type: none"> • Improve storage efficiency and reduce costly square footage from storing plywood harness boards not in use • Reduce labor needed to retrieve and store plywood harness boards
<p>Patent-pending Hole Design</p>	<p>Improve Productivity</p> <ul style="list-style-type: none"> • Locking mechanism is more effective than nails, magnetic or snap-in routing fixtures; accessories stay in place until you're ready to make a change • Easily move accessories from one hole to another to optimize harness layout <p>Improve Profitability</p> <ul style="list-style-type: none"> • Faster setup time as compared to the hammer and nail method • Reduce repetitive work and improve safety from use of hammer and nails
<p>Reusable Accessories</p> <p>Complementary Offering To Traditional Harness Board Accessories</p>	<p>Improve Productivity</p> <ul style="list-style-type: none"> • Reusable and repositionable accessories are designed to be rotated easily to accommodate cable routing pathway • Mounting platforms and mounting pegs improve setup by allowing accessories to be easily changed to ensure consistent harness board designs and configurations • Help to elevate harness routing above the board to allow efficient use of the Panduit Automatic Cable Tie Installation Tool as well as manually installing cable ties, labels, abrasion protection products, tape, etc. <p>Improve Profitability</p> <ul style="list-style-type: none"> • Use with existing Panduit Harness Board Accessories to create a modular system • Reduce expense of storing costly harness board accessories and test fixtures

Quick-Build™ Harness Board System

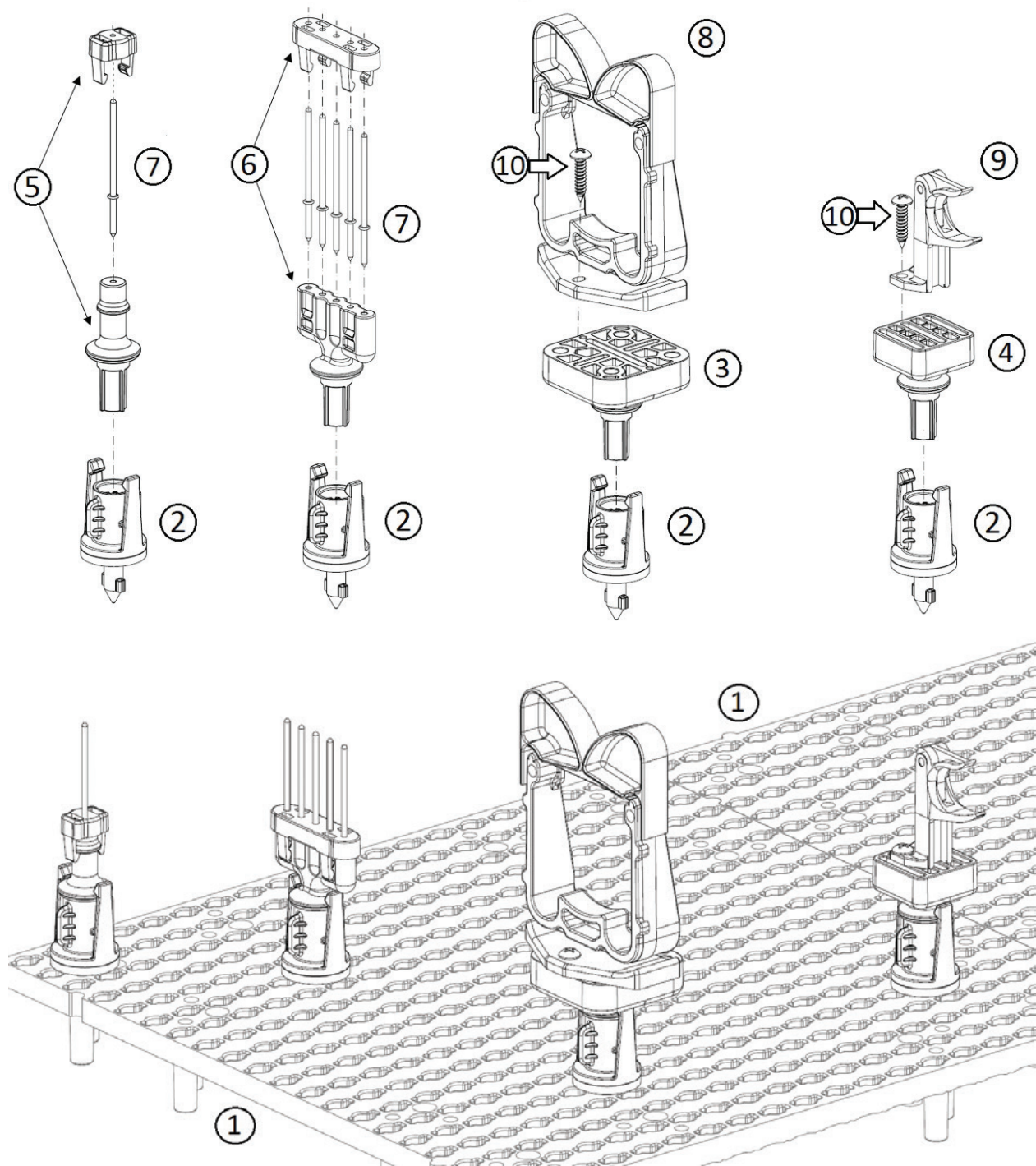

Savings Add Up!

Quick-Build™ Harness Board savings can add up based on your unique variable information such as:

- Labor Cost/Hour
- Number of Board Variations / Harness Configurations
- Average Number of Changeovers for each Harness Annually

Quick-Build™ Grid Tile

①

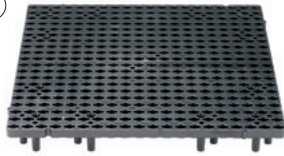

- Install on top of plywood backing to provide mounting surface
- Secure to plywood with user supplied screws

Part Number	Description	Std. Pkg. Qty
QB-TILE	1' X 1' (305mm x 305mm) square base component that allows Quick-Build mounting pegs and platforms to create a modular harness system. One package includes 8 tiles. Black.	1 PK

Quick-Build™ Mounting Pegs

②



- Repositionable to allow user to build different harness configurations as needed
- Pointed end inserts through drawing secured to grid tiles, providing the ability to create a harness on top of a drawing

Replacement Washers	
Part Number	Qty
QB-WASHER-Q	25

Note: Required for use with Quick-Build mounting platform and Quick-Build nail holders to provide a modular harness board system

Part Number	Description	Std. Pkg. Qty
QB-MOUNT-L	Peg can be positioned and relocated. Accepts single nail holders, five nail holders, and Quick-Build™ mounting platforms. Allows accessories to rotate as needed even after mounting peg is installed into grid tile. Black.	50

Quick-Build™ Mounting Platform

③,④



- Requires the use of the Quick-Build mounting pegs to provide a modular solution
- Repositionable, allowing user to build different harness configurations as needed
- Provides the ability to rotate to allow breakouts and cable pathways to accommodate various harness design requirements
- Use Quick-Build mounting screws (sold separately, see page 4) to secure harness board accessories to the Quick-Build mounting platform

Part Number	Description	Std. Pkg. Qty
QB-BASE175-Q	Mounting platform that is inserted in Quick-Build mounting pegs 1.75" x 1.75" (44.45mm x 44.45mm). Allows elastic retainers, wire end holders, corner posts, bundle retainers and other harness board accessories to create a complete Quick-Build™ harness system. Compatible with: #4, #6, #8, and 1/4" screws. Black.	25
QB-BASE120-Q	Mounting platform that is inserted in Quick-Build pegs 1.2" x 1.2" (30.48mm x 30.48mm). Allows test fixtures corner posts, wire end holders, and other harness board accessories to be installed to provide a complete Quick-Build™ harness system. Compatible with #8 screw size. Screw length will vary based on test fixtures and accessories used. Note: Consider multiple QB-BASE120-Q components for large test fixtures. Black.	25

Quick-Build™ Harness Board System

Quick-Build™ Screws

10



- Used to secure traditional harness board accessories and test fixtures to Quick-Build™ mounting platform
- Phillips/slot combination screw style

Part Number	Description	Std. Pkg. Qty
QB-S6-500-C	#6 screw; 1/2" long	100
QB-S8-500-C	#8 screw; 1/2" long	100
QB-S8-750-C	#8 screw; 3/4" long	100
QB-S25-500-C	1/4" screw; 1/2" long	100
QB-S25-1000-L	1/4" screw; 1" long	50

Quick-Build™ Single Nail Holder

5



- Requires the use of the Quick-Build mounting pegs to provide a modular solution
- Repositionable, allowing user to build different harness configurations as needed
- Allows the use of harness board nails (sold separately, see page 6)
- Use with single nails to create pathways and breakout channels

Part Number	Description	Compatible Harness Board Single Nail Part Number (see page 5)	Std. Pkg. Qty
QB-SN1-Q	Single nail holder to accommodate one 1" nail. White	HBN1-T	25
QB-SN2-Q	Single nail holder to accommodate one 2" nail. Black	HBN2-T	25
QB-SN3-Q	Single nail holder to accommodate one 3" nail. Gray	HBN3-T	25

Quick-Build™ Five Nail Holder

6



- Requires the use of Quick-Build mounting pegs to provide a modular solution
- Repositionable, allowing user to build different harness configurations as needed
- Allows the use of up to five harness board nails (sold separately, see page 6)
- Use with nails to create pathways and breakout channels with harness board nails

Part Number	Description	Compatible Harness Board Single Nail Part Number (see page 5)	Std. Pkg. Qty
QB-FN1-Q	Five nail holder to accommodate up to five 1" nails. White	HBN1-T	25
QB-FN2-Q	Five nail holder to accommodate up to five 2" nails. Black	HBN2-T	25
QB-FN3-Q	Five nail holder to accommodate up to five 3" nails. Gray	HBN3-T	25

Quick-Build™ Grid Tile Connector

Not Shown



- Optional accessory for use with grid tiles to prevent the need for plywood backing and ensure accurate alignment of grid system
- Recommended for adjacent tiles where corners of two or four tiles come together

Part Number	Description	Std. Pkg. Qty
QB-CONN	Grid tile connector to ensure accurate alignment of Grid System. One package includes five pieces. Black	1 PK

Traditional Harness Board Accessories

Panduit harness board accessories have been around for a long time and continue to provide easy routing and forming of wires in harness fabrication.

Harness Board Nails

7



- Manufactured from Nickel Plated Steel
- Smooth finish on nails prevents abrasion to wire jackets

Part Number	Description	Compatible QB Components (see pg 4)	Std. Pkg. Qty
HBN1-T	Harness Board Nail - 1" long (1.65" overall).	QB-SN1-Q and QB-FN1-Q	200
HBN2-T	Harness Board Nail - 2" long (2.66" overall).	QB-SN2-Q and QB-FN2-Q	200
HBN3-T	Harness Board Nail - 3" long (3.67" overall).	QB-SN3-Q and QB-FN3-Q	200

Elastic Retainers – Replaceable Version

8



- Cable bundles are formed as individual wires are inserted
- Completed bundles can be easily removed
- The elastic band is replaceable

Replacement Elastic	
Part Number	Qty
RER.5E-X	10
RER.75E-X	10
RER1.25E-X	10
RER2.0E-X	10

Part Number	Description	Compatible QB Components (see pages 4, 5)	Std. Pkg. Qty
RER.5-S6-X	Elastic retainer with replaceable elastic band. Suitable for 0.5" maximum bundle capacity.	QB-BASE175-Q and QB-S6-500-C	10
RER.75-S6-X	Elastic retainer with replaceable elastic band. Suitable for 0.75" maximum bundle capacity.		10
RER1.25-S6-X	Elastic retainer with replaceable elastic band. Suitable for 1.25" maximum bundle capacity.		10
RER2.0-S6-X	Elastic retainer with replaceable elastic band. Suitable for 2.0" maximum bundle capacity.		10

Elastic Retainers

Not Shown



- Cable bundles are formed as individual wires are inserted
- Completed bundles can be easily removed

Part Number	Description	Compatible QB Components (see pages 4, 5)	Std. Pkg. Qty
ER.5-E4-X	Elastic Retainer. Suitable for 0.5" maximum bundle capacity.	QB-BASE175-Q and QB-S6-500-C	10
ER1.25-E4-X	Elastic Retainer. Suitable for 1.25" maximum bundle capacity.	QB-BASE175-Q and QB-S6-500-C	10

Quick-Build™ Harness Board System

Bundle Retainers

Not Shown



- Funnel entry allows fast cable insertion
- Completed bundles can be easily removed

Part Number	Description	Compatible QB Components (see pages 4, 5)	Std. Pkg. Qty
BR.5-E6-C	Bundle Retainer. Suitable for 0.5" maximum bundle capacity. 1.07" standoff height. Black	QB-BASE175-Q and QB-S6-500-L	100
BR.75-E6-C	Bundle Retainer. Suitable for 0.75" maximum bundle capacity. 0.95" standoff height. Black	QB-BASE175-Q and QB-S6-500-L	100
BR2-1.3-X	Bundle Retainer. Suitable for 2.0" maximum bundle capacity. 1.32" standoff height. Black	QB-BASE175-Q and QB-S25-500-L	10
BR2-1.5-X	Bundle Retainer. Suitable for 2.0" maximum bundle capacity. 1.59" standoff height. Black	QB-BASE175-Q and QB-S25-1000-L	10
BR2-4-X	Bundle Retainer. Suitable for 2.0" maximum bundle capacity. 4.06" standoff height. Black	QB-BASE175-Q and QB-S25-1000-L	10
BR2-6-X	Bundle Retainer. Suitable for 2.0" maximum bundle capacity. 6.02" standoff height. Black	QB-BASE175-Q and QB-S25-1000-L	10

Corner Posts

9



- Designed to pre-form tight bundles at harness corners and breakouts
- Top arm rotates upward for easy removal of completed harness

Part Number	Description	Compatible QB Components (see pages 4, 5)	Std. Pkg. Qty
CPH.75-S8-X	Corner post to assist in tight corners of harness systems. 0.75" maximum bundle diameter. Center of bundle is 1.35" from surface.	QB-BASE120-Q or QB-BASE175-Q and QB-S8-500-C	10
CPL.75-S8-X	Corner post to assist in tight corners of harness systems. 0.75" maximum bundle diameter. Center of bundle is 0.56" from surface.	QB-BASE120-Q or QB-BASE175-Q and QB-S8-500-C	10

Wire End Holder

Not Shown

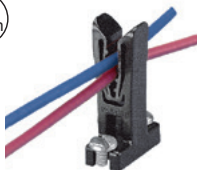

- Secures wire ends while harness is being fabricated
- Use with #28 thru #16 AWG wires

Part Number	Description	Compatible QB Components (see pages 4, 5)	Std. Pkg. Qty
WEH-E8-C	Use to retain end of wire in secure position. Helps when making terminations or dressing harness.	QB-BASE120-Q or QB-BASE175-Q and QB-S8-500-C	100

Fanning Strip System

Not Shown



- Holds wires in a specific orientation
- No sharp edges to damage wire insulation
- Accepts wires up to 18 AWG
- Fanning strip can remain as part of completed harness

Part Number	Description	Compatible QB Components (see pages 4, 5)	Std. Pkg. Qty
FSH40-X	Fanning strip holder to elevate FS156 Fanning Strip 0.62" above surface. 6.00" long. Black	QB-BASE120-Q or QB-BASE175-Q and QB-S8-500-C	10
FSHH-X	Fanning strip holder to elevate FS156 Fanning Strip 1.42" above surface. 3.2" long. Black	QB-BASE120-Q or QB-BASE175-Q and QB-S8-500-C	10
FS156-C	Fanning strip with 76 spaces for wires up to 18 AWG. 12.1" long and 0.31" tall.	N/A	100

Spring Wire Breakout System

Not Shown

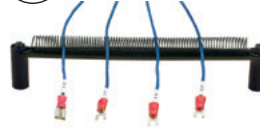



- Harness board spring and spring holder secures wire ends while harness is being fabricated
- Wires simply pull out from spring when harness is removed
- Each SHH Spring Holder is supplied with one rigid wire piece to hold the spring laterally and two #8 (M4), 2" (50.8mm) hex head wood screws; purchase spring separately.

Part Number	Description	Compatible QB Components (see pages 4, 5)	Std. Pkg. Qty
SHH1-S8-X	Spring Wire Holder that elevates spring 1.3" above surface. Compatible with PBSC1-X spring. Black	QB-BASE120-Q or QB-BASE175-Q and QB-S8-500-C	100
SHH3-S8-X	Spring Wire Holder that elevates spring 1.3" above surface. Compatible with PBSC3-X spring. Black	QB-BASE120-Q or QB-BASE175-Q and QB-S8-500-C	100
PBSC1-X	Spring compatible with SHH1-S8-X Spring Wire Holder.	NA	10
PBSC3-X	Spring compatible with SHH3-S8-X Spring Wire Holder.	NA	10
PBSC6-X	Spring used independent of Spring Wire Holder. Requires 6" spacing for mounting. Can be secured directly to Quick-Build Mounting Platform.	QB-BASE175-Q and QB-S25-500-L	10
PBSC12-X	Spring used independent of Spring Wire Holder. Requires 12" spacing for mounting. Can be secured directly to Quick-Build Mounting Platform.	QB-BASE175-Q and QB-S25-500-L	10

Quick-Build™ Harness Board System

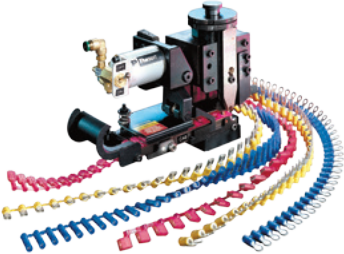
Complete your harness assembly with:

	<p>Automatic Cable Tie Installation Systems and Reel-Fed Cable Ties</p> <ul style="list-style-type: none">• Engineered for high-volume efficiency and operator ease to minimize installed costs and boost profits• Reduce reel-change downtime with Panduit continuous, reel-fed cable ties <p>6X FASTER than conventional cable tie installation systems</p> <p>LESS THAN 1 SECOND Wrap, tension and cut cable ties in less than 1 second</p>
	<p>Automated Termination System</p> <ul style="list-style-type: none">• Speeds the process of indexing and crimping connectors resulting in consistent quality terminations to minimize installed cost and boost profits• Choose from a wide selection of molded disconnects, splices, rings, forks, pins, and ferrules on reels <p>Measure your productivity gains:</p> <p>Fast and easy die changeovers save time</p> <p>UP TO 30% FASTER crimp cycle time</p>
	<p>Identification</p> <ul style="list-style-type: none">• Proper wire harness identification improves quality assurance and ensures compliance with industry standards• Desktop printers and labeling software provide fast, high-quality label production• Available in a wide variety of materials for wire and cable identification, including heat shrink labels, self-laminating labels, turn-tell labels, and marker plates <p>Reduce time for labeling by up to 75%</p>
	<p>Abrasion Protection</p> <ul style="list-style-type: none">• Insulate, protect, and color code wires to help ensure high-quality performance even in demanding environments• Choose from Pan-Wrap™, spiral wrap, corrugated loom tubing and braided sleeving, and heat shrink <p>Protect from vibration and environmental factors Bundle and route wires and cables efficiently</p>

Tel: +44(0) 1793616700 • Fax: +44(0) 1793 644304
uksales@is-rayfast.com • export@is-rayfast.com

www.is-rayfast.com

2 Lydiard Fields, Swindon, Wiltshire, SN5 8UB

